

# ESENA

# RTV 2D1S

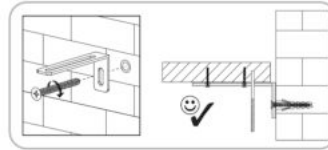

Ø8

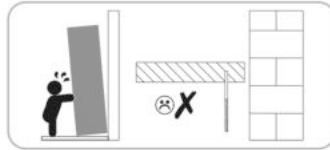
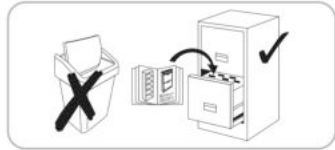
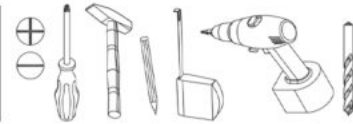
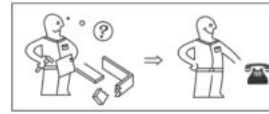
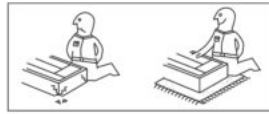
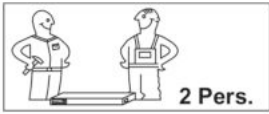
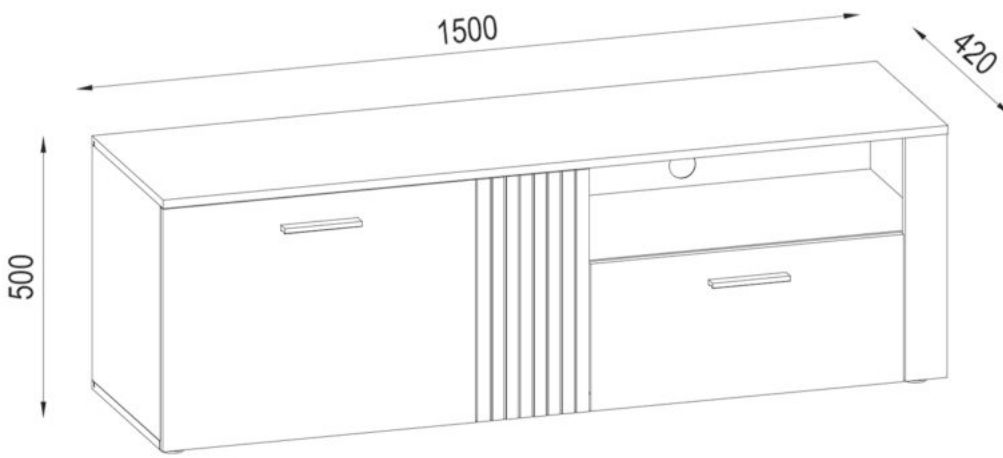

- utáhnout
- stlačit
- změřit
- stisknout
- zatlout
- otočit - obrátit

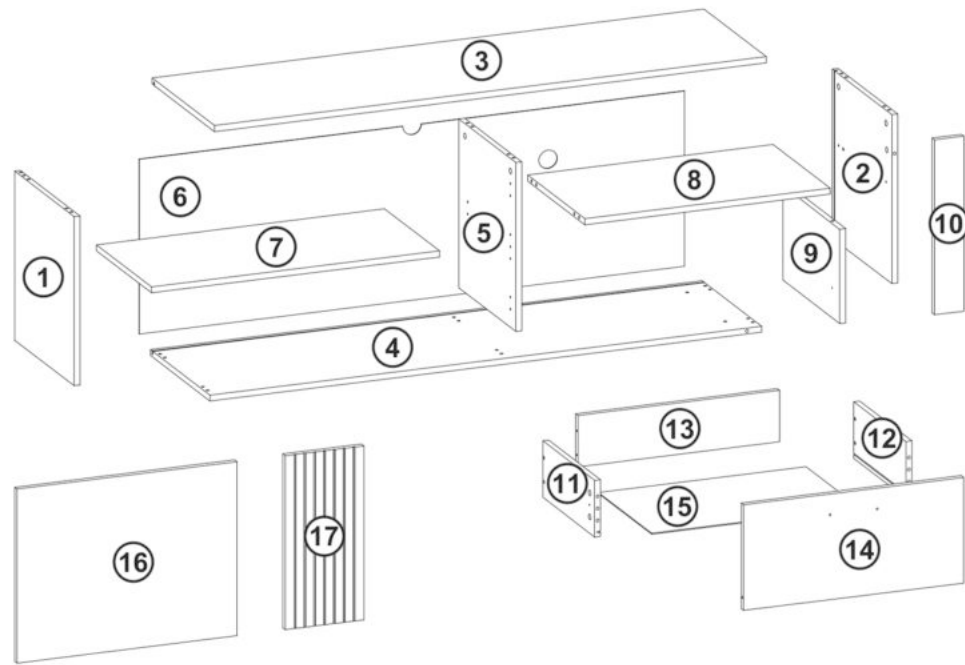







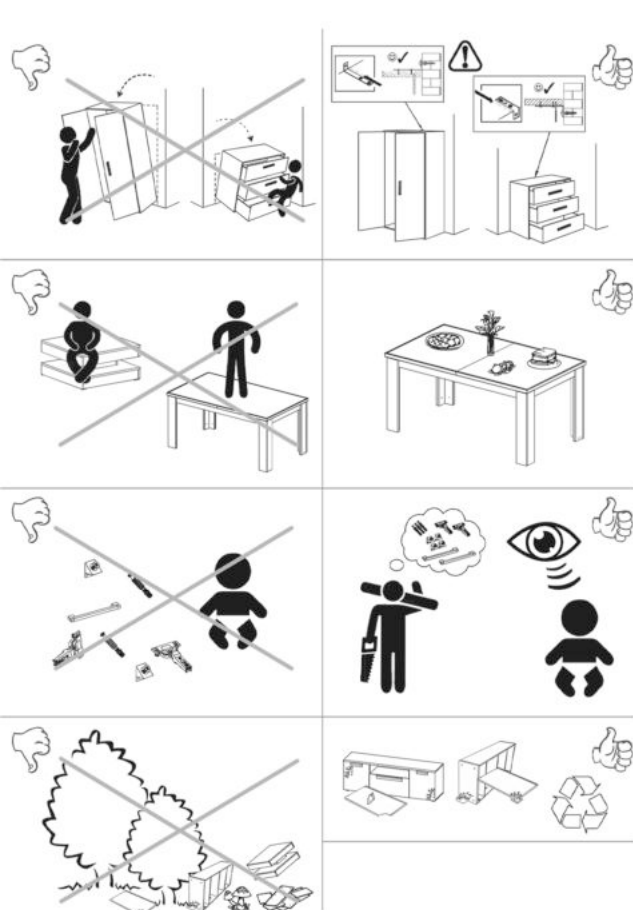







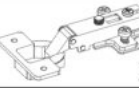



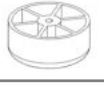

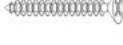



max. 3KG = 15    max. 5KG = 7 8    max. 10KG = 3 4

A	B (mm)		C	D
1	448	400	16	x1 1/2
2	448	400	16	x1 1/2
3	1500	420	16	x1 2/2
4	1500	400	16	x1 2/2
5	448	384	16	x1 1/2
6	464	1482	2,5	x1 2/2
7	783	370	16	x1 2/2
8	667	384	16	x1 2/2
9	250	384	16	x1 1/2

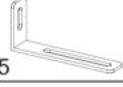
A	B (mm)		C	D
10	464	80	16	x1 2/2
11	350	150	16	x1 1/2
12	350	150	16	x1 1/2
13	548	136	16	x1 2/2
14	598	280	16	x1 2/2
15	564	358	2,5	x1 1/2
16	598	461	16	x1 1/2
17	461	214	16	x1 1/2
B1				1/2



<b>A1</b> 15x12  x16	<b>C2</b> 44mm  x16	<b>B2</b> 8x30  x22
<b>FA1</b> 4mm  x1	<b>F3</b> 6,3x50  x10	<b>O3</b> Ø18  x6
<b>K6</b> Ø35  x4	<b>J65</b> 128/148  x2	<b>O4</b> Ø18  x5
<b>M1</b> 10x10x15  x10	<b>P14</b> 45x20  x5	<b>N1</b> Ø6  x4
<b>D25</b> 4x25  x5	<b>DA21</b> 4,2x16  x8	<b>DB2</b> 4x25  x4
<b>E5</b> 5x11  x4	<b>D11</b> 3,5x16  x10	<b>D10</b> 3x16  x4
<b>R10</b> Ø10  x2	<b>I6</b> 350  x1	<b>Y36</b> 75x32x15  x1
	<b>Y37</b> 8x50  x1	<b>Y35</b> 4,2x65  x1
		<b>R6</b>  x1

Náš nábytek se musí používat podle předpisů. Používání v rozporu s předpisy může vést k věcným škodám a za jistých okolností také k zraněním osob. Nábytek není hračka. Za škody, které vzniknou používáním proti předpisům nebo nesprávnou manipulací, nepřijímá výrobce nebo prodejce žádnou zodpovědnost.

**POZOR:** Děti nebo osoby s mentálním postižením se musí neustále držet mimo dílů nábytku, špičatých předmětů, drobných částí a obalových materiálů, protože hrozí riziko zranění a/nebo udušení.

**MONTÁŽ:** Při montáži dodržujte náš návod k používání, obsluze, instalaci nebo montáži a dávejte hlavně pozor na výstražné a bezpečnostní pokyny. Pokud se nebudou dodržovat předpisy, může to mít za následek zranění osob nebo poškození nábytku / ohrožení bezpečnosti. Pokud byste měli potíže s instalací/montáží, kontaktujte náš servisní tým. Tento vám ochotně poradí a pomůže. Montáž smí provádět pouze kvalifikovaný personál. Při změnách na produktu/dílechproduktu, při výměně nebo použití dílů/spotřebních materiálů, které nepocházejí od výrobce/prodejce, nepřijímáme žádnou odpovědnost za škody.

Pokud jsou ke zboží přiloženy upevňovací prvky na zeď, jako jsou hmoždinky a šrouby, jsou tyto určeny výhradně pro použití na stěnách z pevných a jedolitých materiálů. Upevnění je jen tak dobré, jak dobré je spojení mezi upevňovacím prostředkem a stěnou. Před upevněním musíte zkontrolovat vhodnost vaší stěny pro stojící i závěsný nábytek a použít pouze vhodné spojovací prvky. Před případným vrtáním se ujistěte, že se v oblasti vrtání nenachází elektrické vodiče. Nakonec je za upevnění na stěnu odpovědný instalační technik.

Platí to také pro instalaci elektrických produktů a dalšího stavebně-technického příslušenství. Montáž/instalaci elektrických produktů a také dalšího důležitého konstrukčního příslušenství může provádět pouze autorizovaný kvalifikovaný personál. Veškeré elektrické a stavebně-technické instalace musí být provedeny v souladu s platnými normami a bezpečnostními předpisy ve vaší zemi. Pro světelné zdroje používejte pouze povolenou intenzitu osvětlení. Při nedodržení max. počtu Watt hrozí riziko požáru v důsledku přehřátí. Překryvání svítidel není povoleno z důvodu rizika požáru.

Dokonale funkce nábytku je zaručena pouze při vertikální a horizontální instalaci. Dveře jsou předem nastavené, mohou se ale znovu seřadit/nastavit na základě místních podmínek. Dodržujte údaje o hmotnostní pro maximální zatížení. Na nábytek se nesmí lézt. Při neoborném použití může dojít k převrácení nábytku. Aby se tomu zamezilo, musí být nábytek neustále zajištěn proti převrácení. Při přetížení/nadměrném přetížení (zejména hračkami, lidmi, materiálem nebo jinými nevhodnými vlivy) hrozí riziko rozbití a zranění. Všechny šrouby a nosná spojovací místa by měla být dotazena po 5 až 6 týdnech, aby se zajistila trvalá stabilita.

#### PÉČE:

-Pokyny k péči o nábytek-

Dodržujte naše pokyny pro správnou péči o nábytek, abyste si náš výrobek mohli užívat co nejdéle. Při čištění používejte čistý, suchý a měkký bavlněný hadřík. Pokud potřebuje váš nábytek důkladné vyčištění, můžete hadřík navlhčit trochou vody nebo čisticího prostředku na nábytek a pak vyčištěné věci vysušit. Kovové a skleněné díly se nejlépe čistí běžně dostupnými čisticími prostředky na kovy a sklo podle pokynů, které jsou na nich uvedené. Na čisticích prostředcích musí být jasně uvedeno, že jsou vhodné k čištění nábytku.

V žádném případě nepoužívejte parní čističe, žíraviny, abraziva nebo jiné prostředky, jejichž účinky neznáte. **POZOR:** Vysoce lesklé povrchy jsou při dodávce chráněny ochrannou fólií. Nechte fólii na nábytku, dokud nebude zcela smontován a zbaven prachu. Vysoce lesklé prvky, ze kterých byla odstraněna ochranná fólie, lze čistit a používat až po 72 hodinách (doba pro následné vytvrzení na okolním vzduchu). Povrchy nelze poškodit ostrými předměty a nikdy je nemůžete vystavovat silnému slunečnímu záření.

#### LIKVIDACE

-Pokyny k likvidaci odpadu-

V zájmu ochrany životního prostředí vyhazujte obalový odpad rozříděný podle druhu do určených odpadkových/recyklačních nádob, v žádném případě nevyhazujte do přírody. Poškozený nebo nepoužitelný nábytek lze odeslat do speciálních sběrných zařízení k recyklaci jednotlivých dílů. Používaný, ale stále funkční nábytek není nutné hned likvidovat. Darujte je např. charitativním organizacím.

Přejeme vám mnoho zábavy s vašim novým nábytkem.

# 1

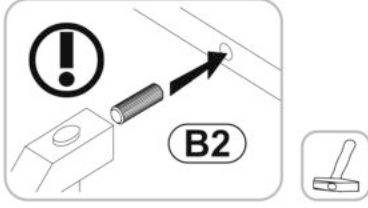
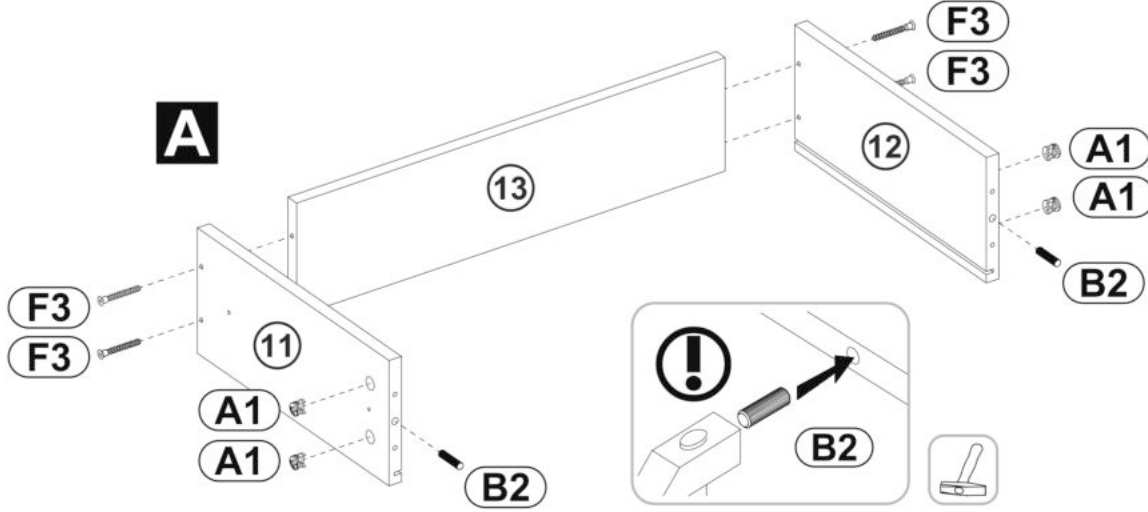
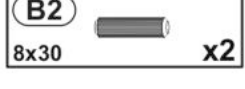
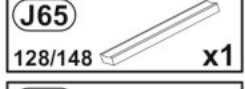
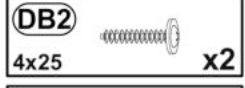
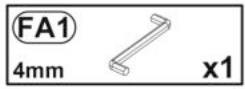
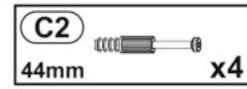
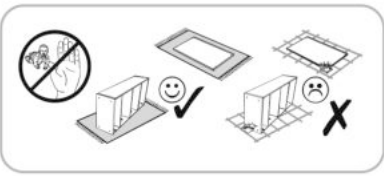

## B

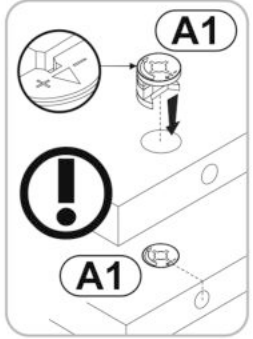
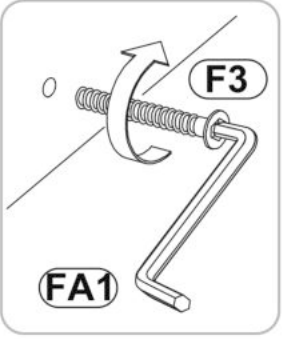
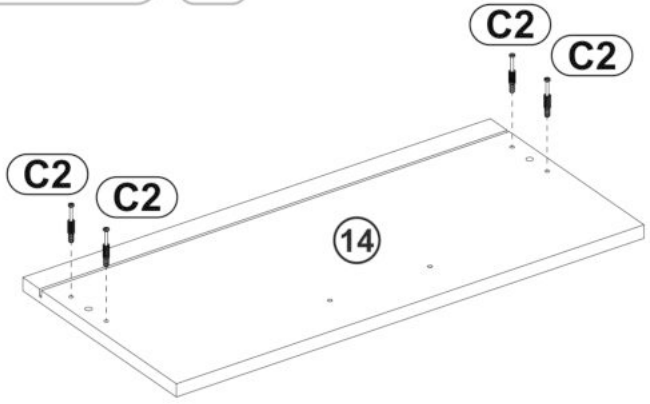

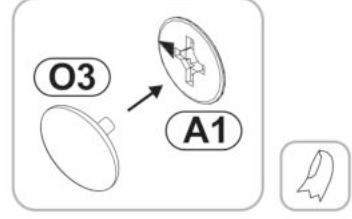
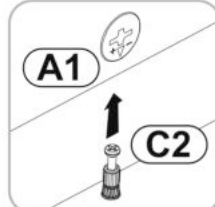
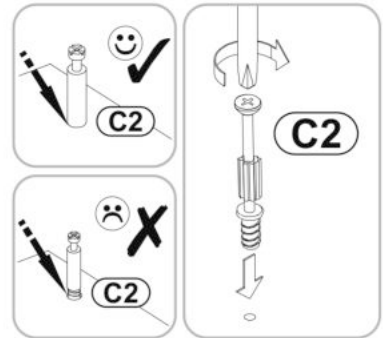
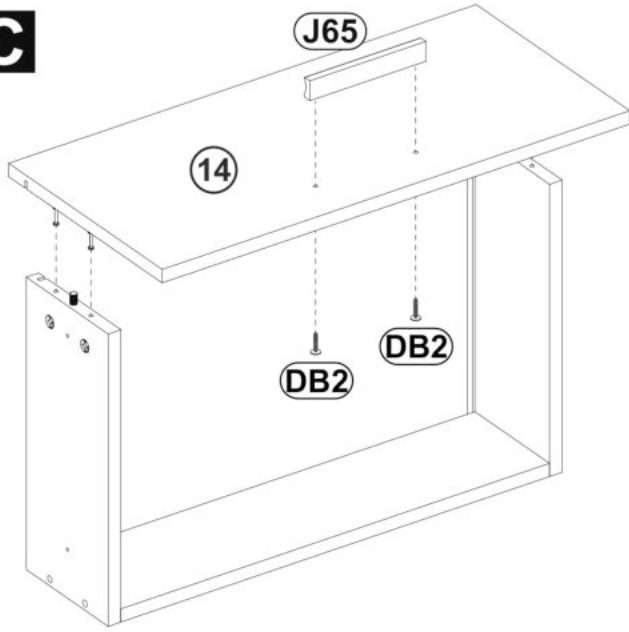

## C

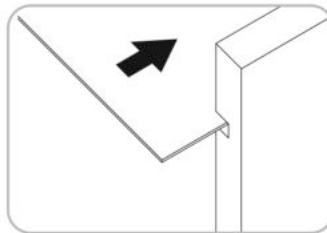
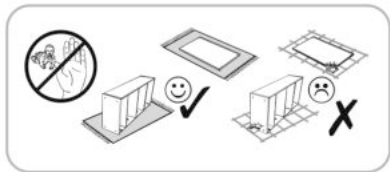

# 2



<b>DA21</b> 4,2x16		<b>x4</b>
<b>I6</b> 350		<b>x1</b>
<b>D10</b> 3,0x16		<b>x4</b>

## D

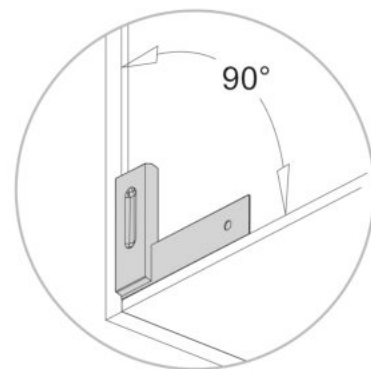
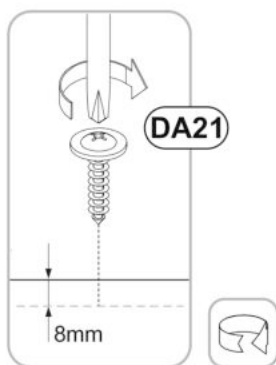
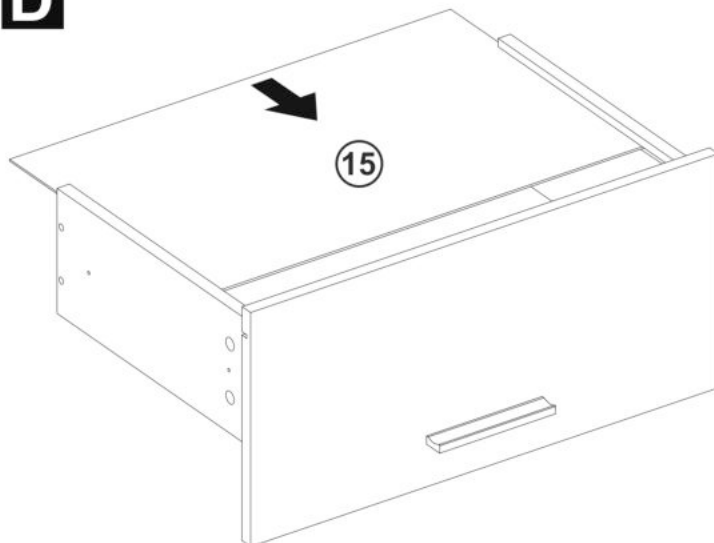

**A=B**

## E

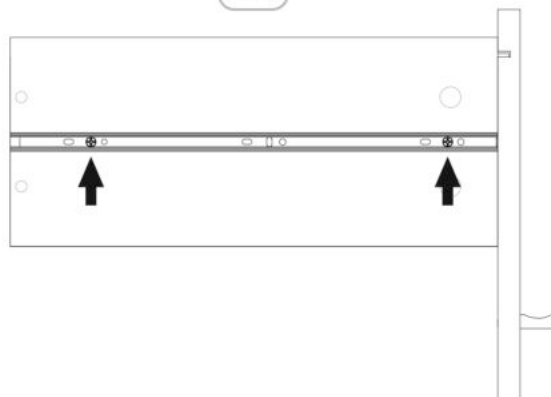
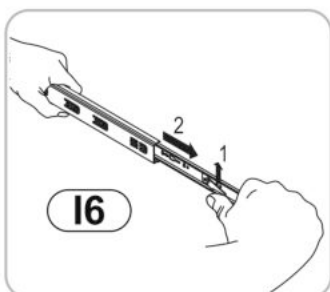
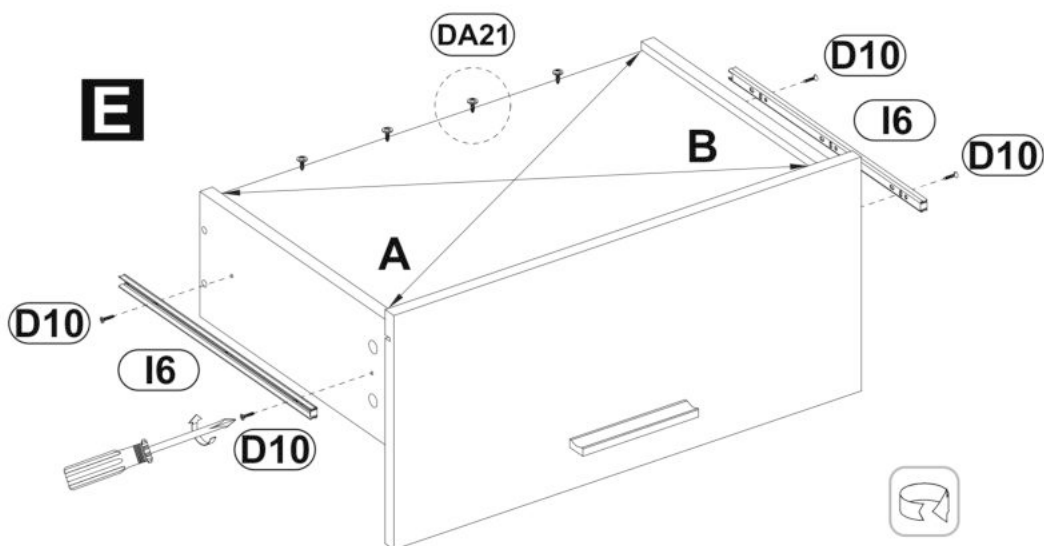

# 3

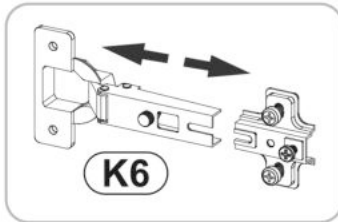
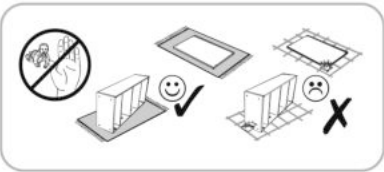

**A1**  
15x12 x9

**B2**  
8x30 x12

**K6**  
Ø35 x2

**C2**  
44mm x2

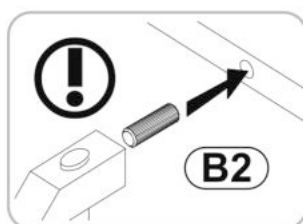
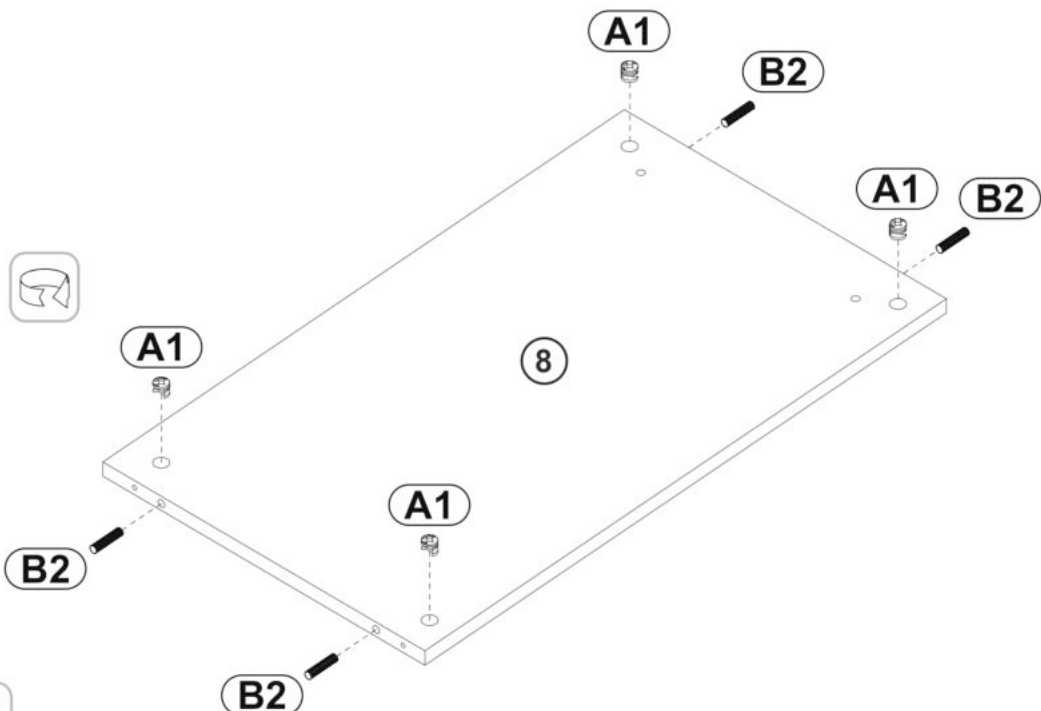
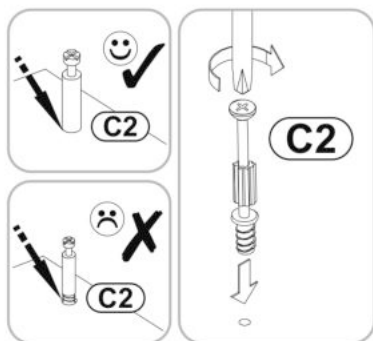
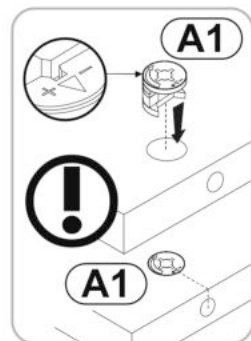
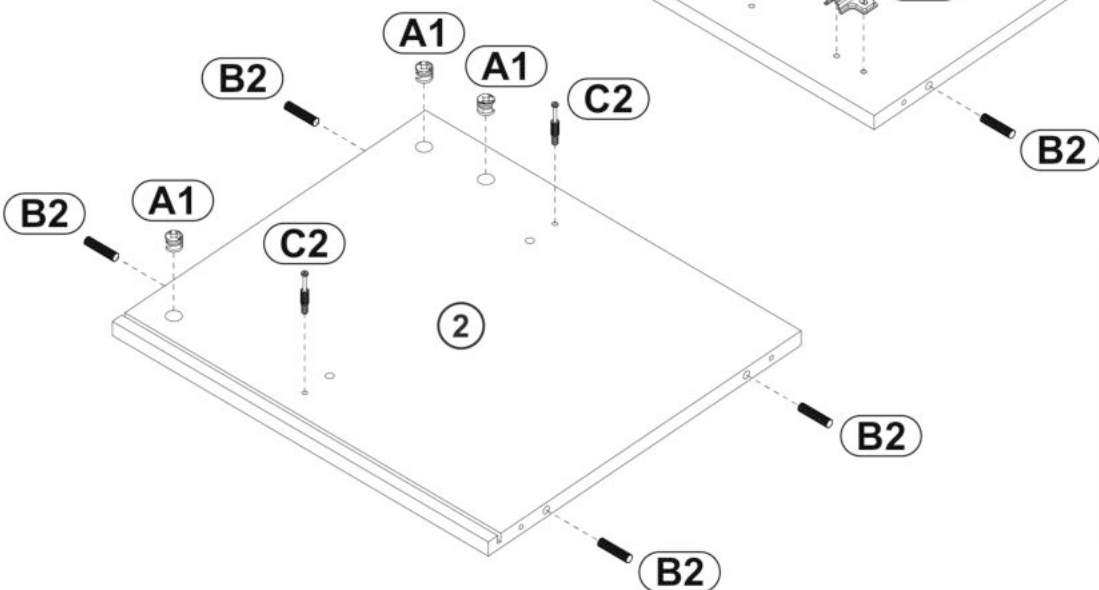
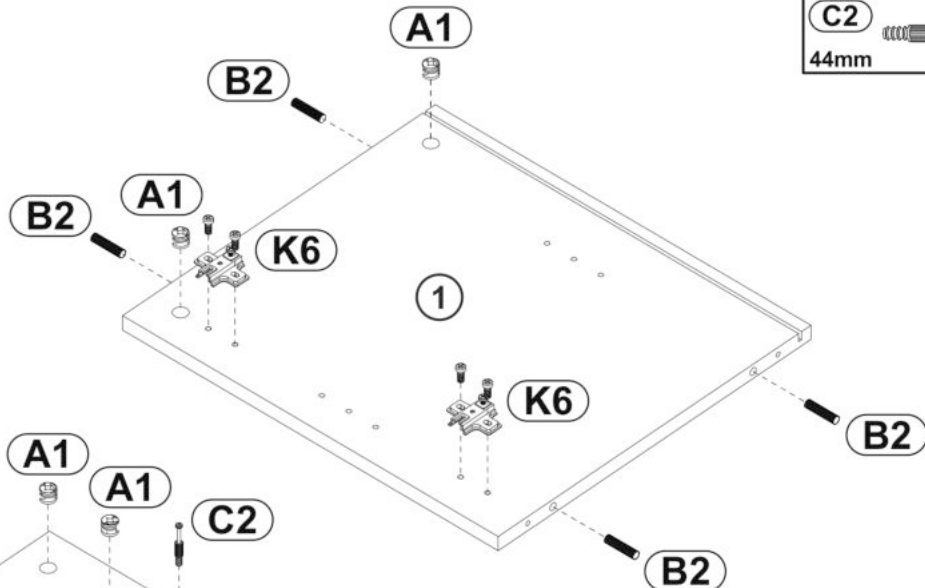
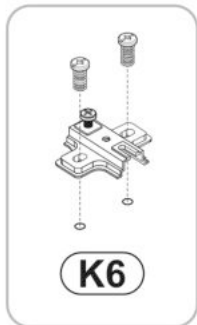

# 4

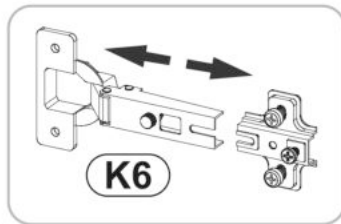
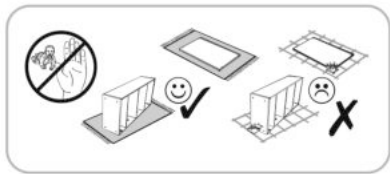

- A1** 15x12 x2
- C2** 44mm x2
- B2** 8x30 x8
- K6** Ø35 x2
- I6** 350 x1
- E5** 5x11 x4

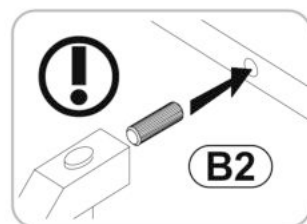
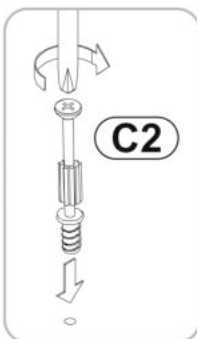
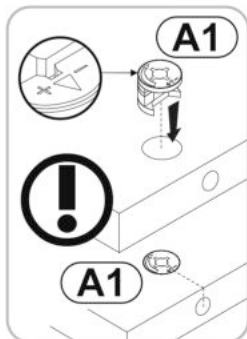
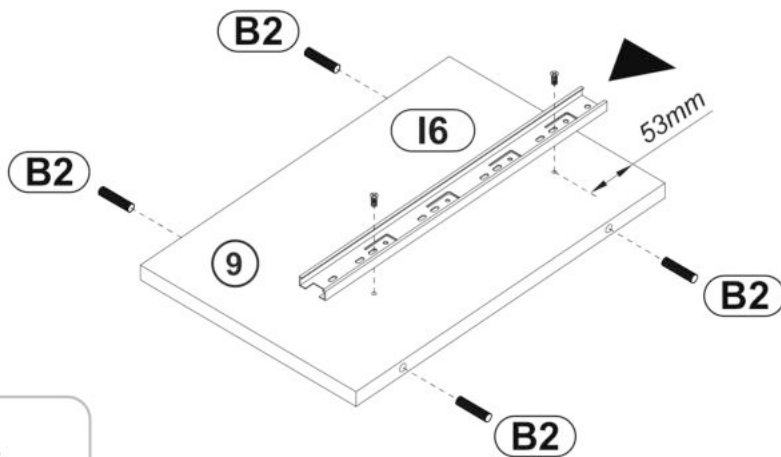
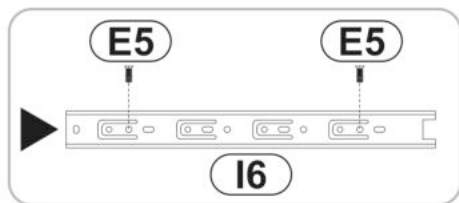
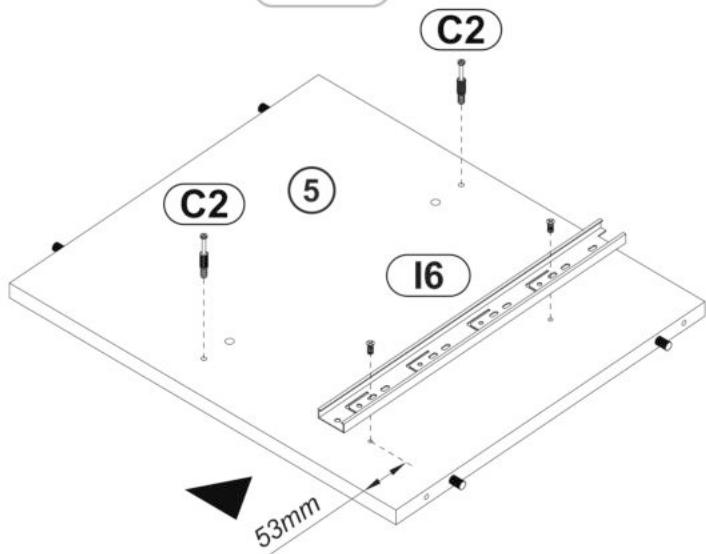
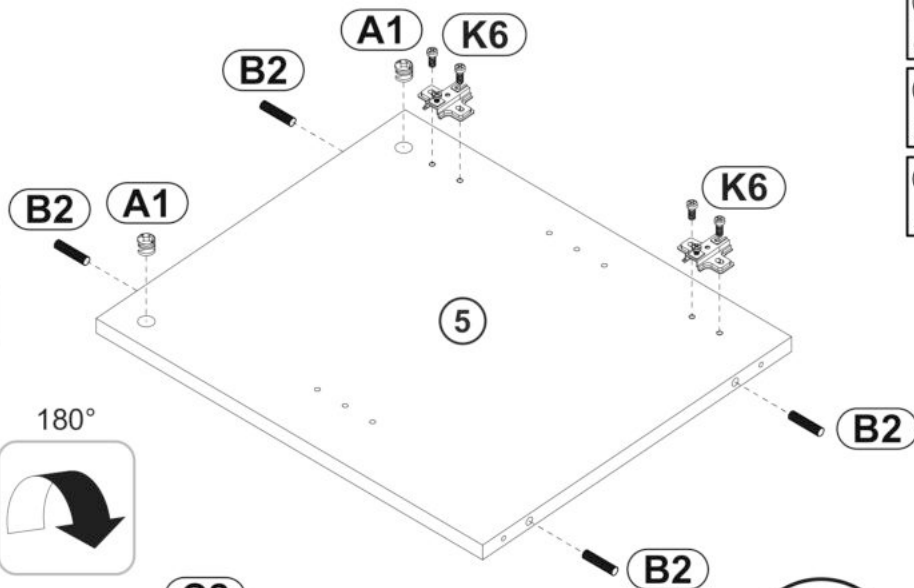
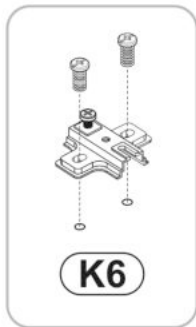

# 5

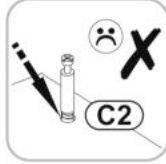
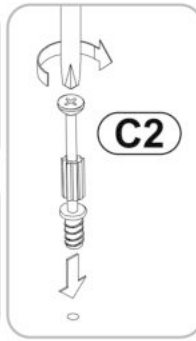
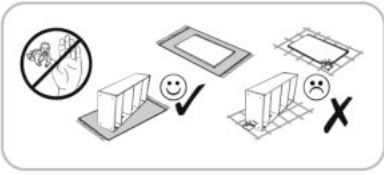

<b>C2</b>		<b>x8</b>
44mm		
<b>A1</b>		<b>x1</b>
15x12		
<b>Y36</b>		<b>x1</b>
75x32x15		
<b>D11</b>		<b>x2</b>
3,5x16		

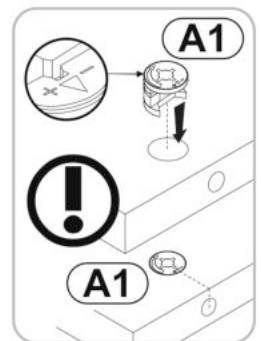
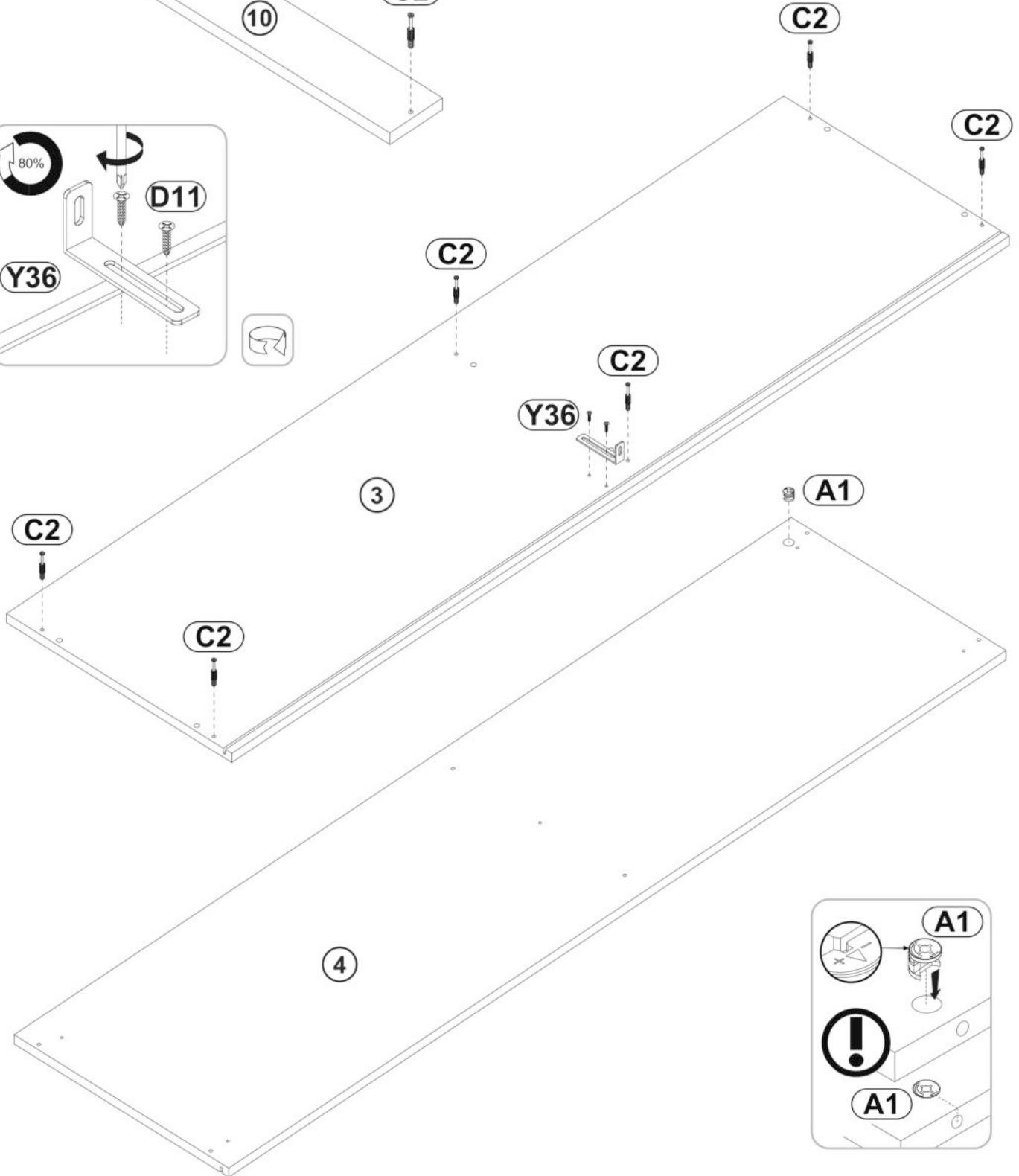
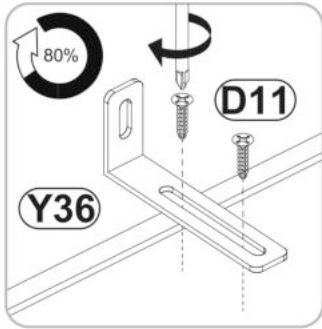
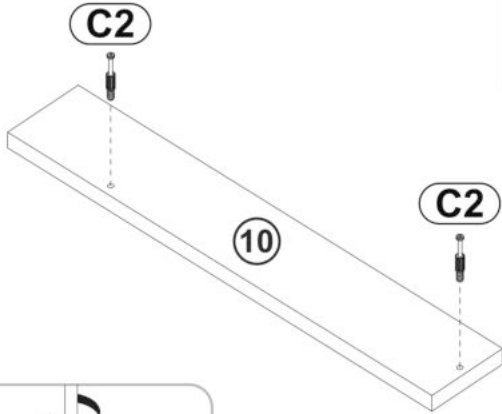

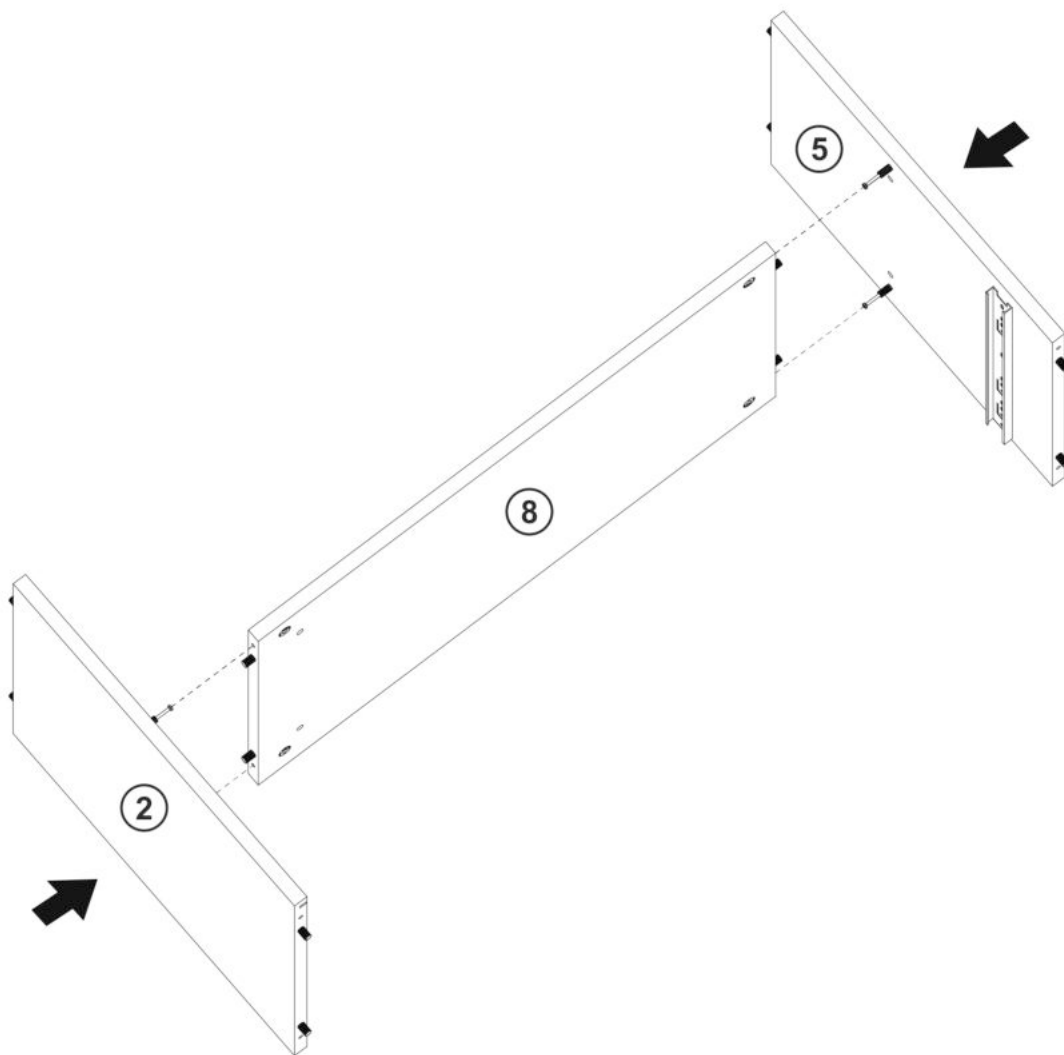
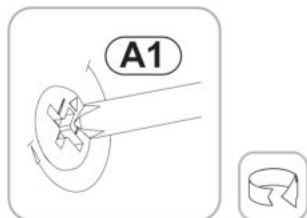
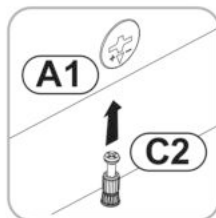
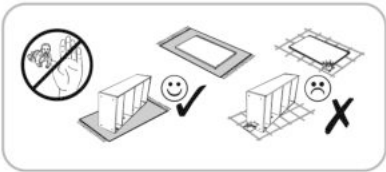

6



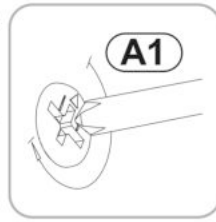
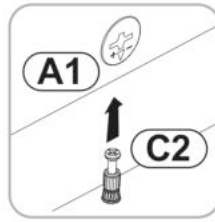
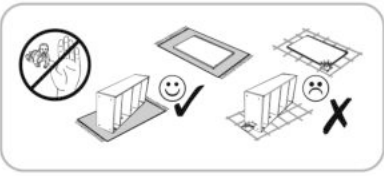

# 7



**O4**  **x4**  
Ø18

**O3**  **x2**  
Ø18

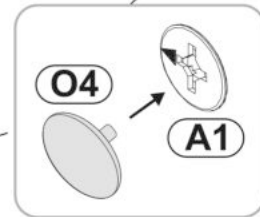
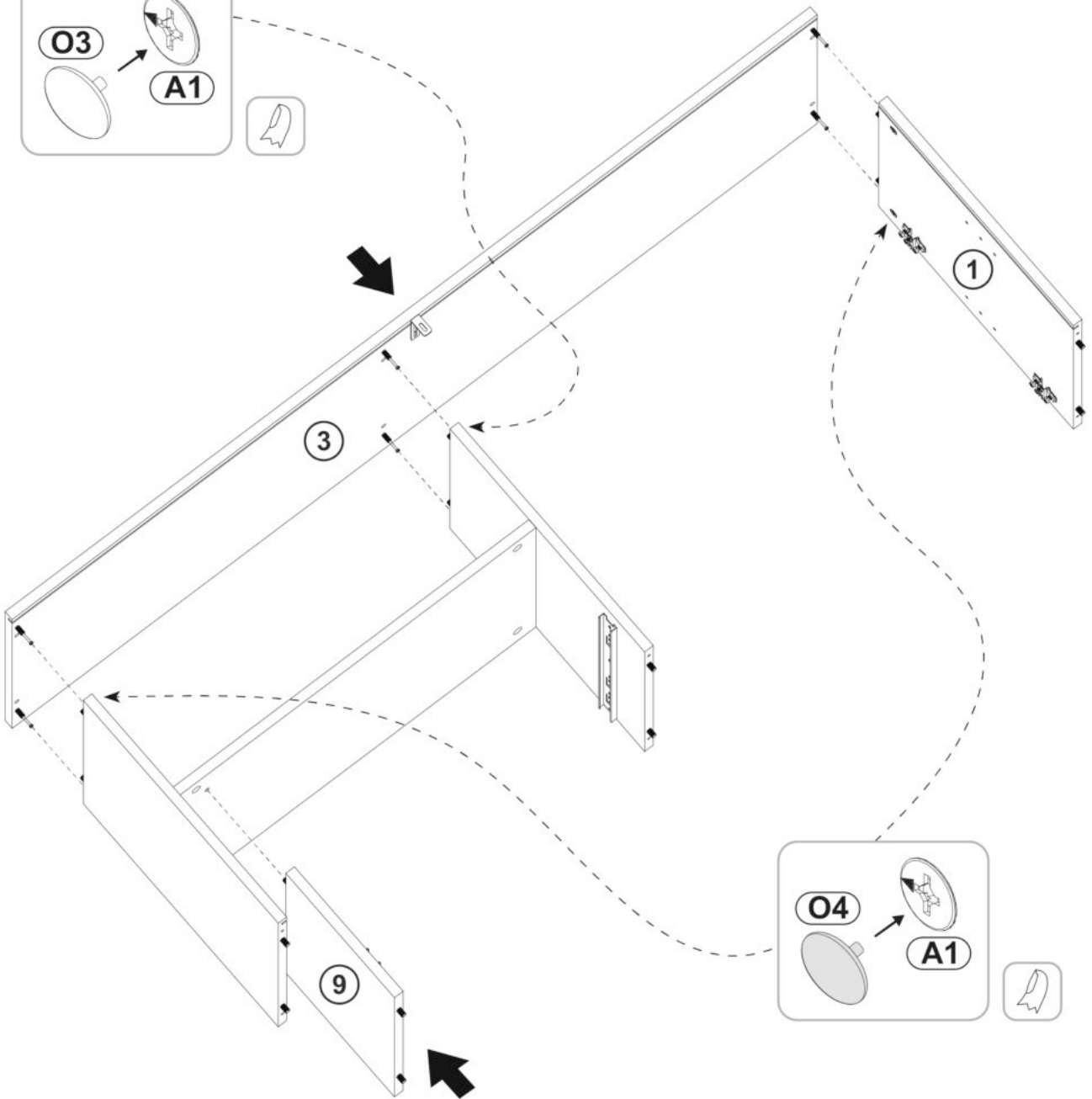
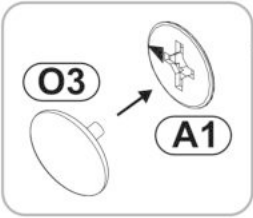

8

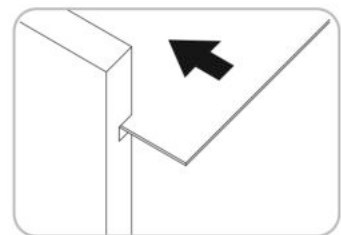
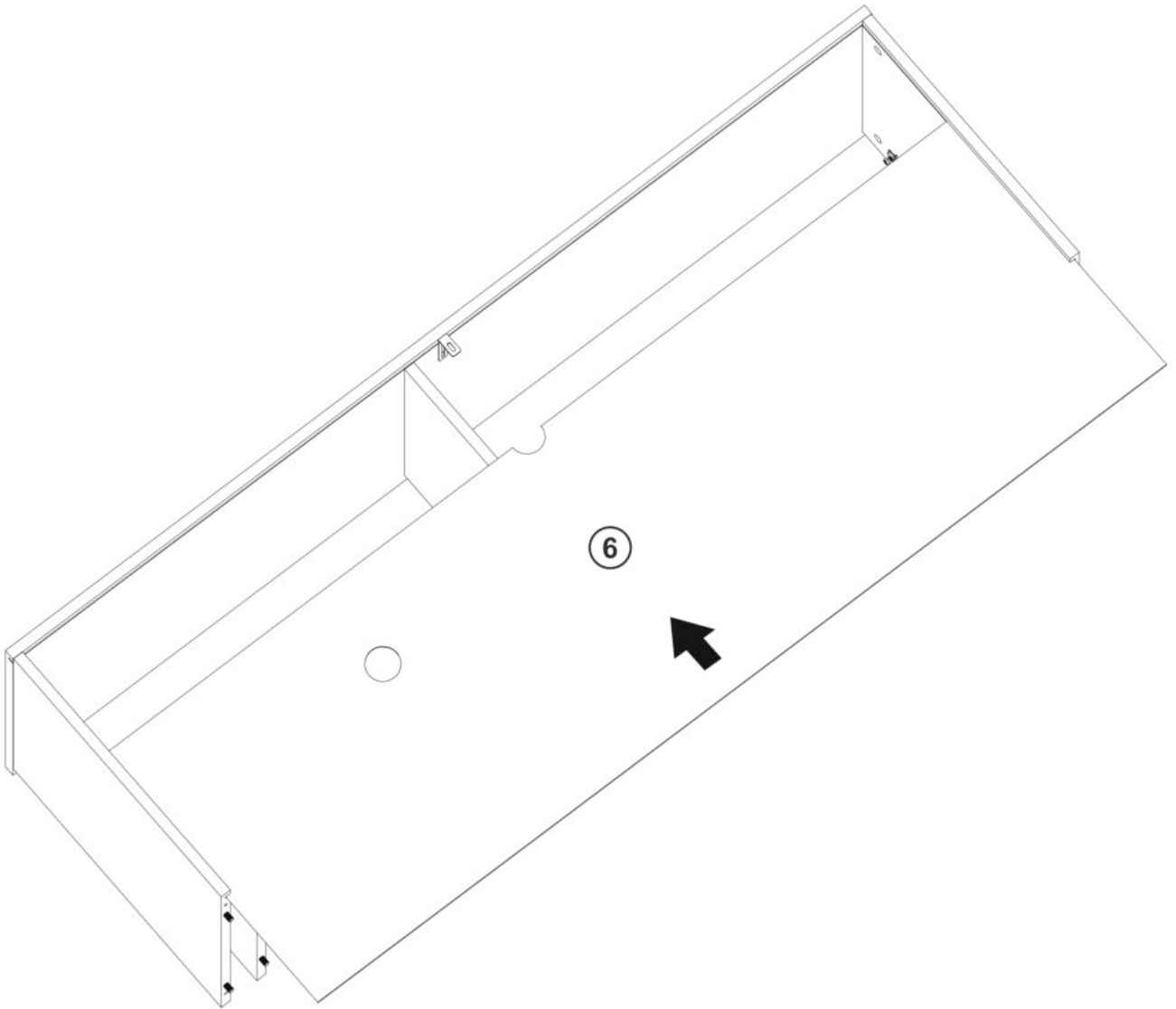
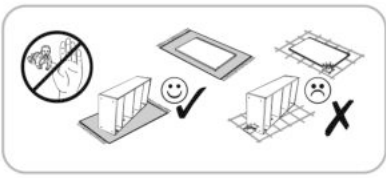

9

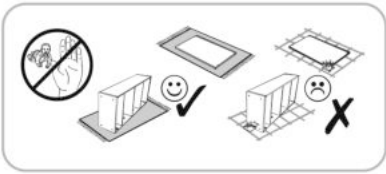

**FA1**  
4mm x1

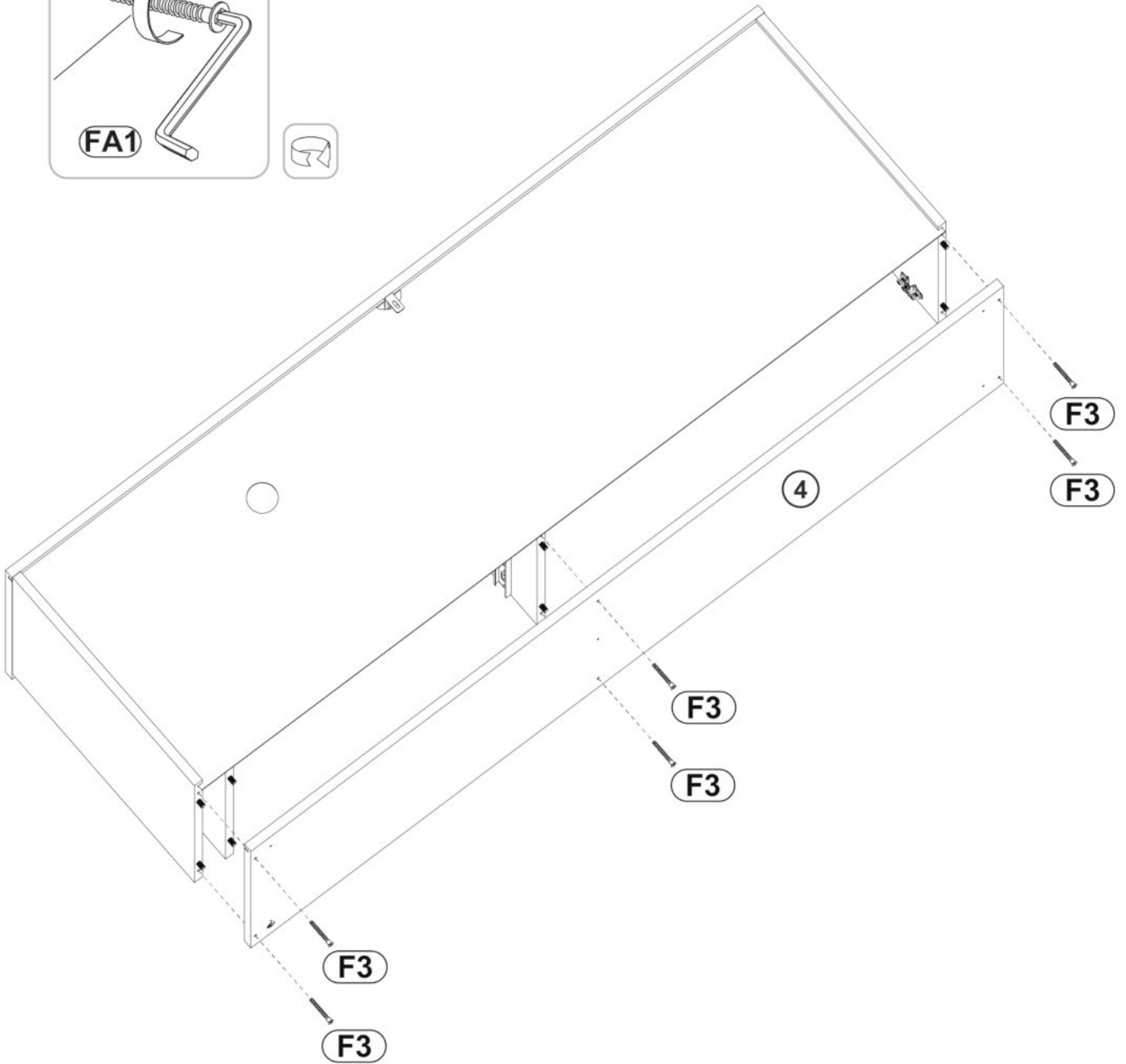
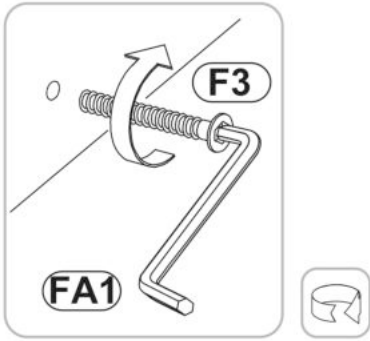

**F3**  
6,3x50 x6

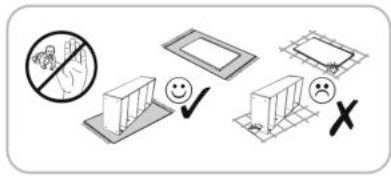

10

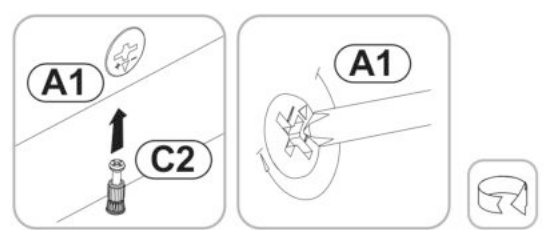
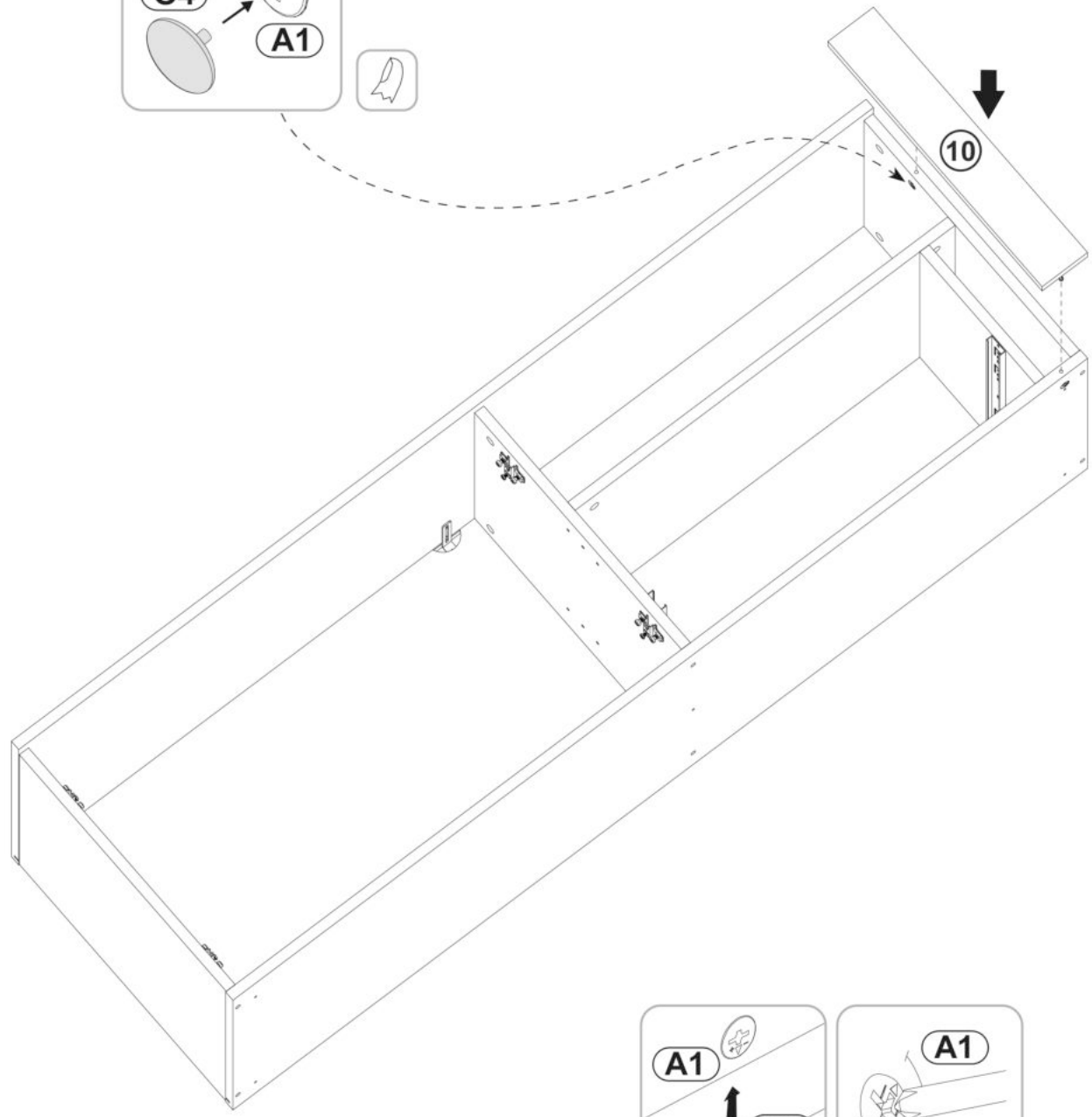
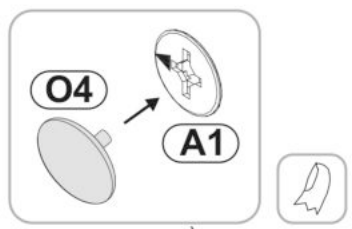

O4  
Ø18 x1



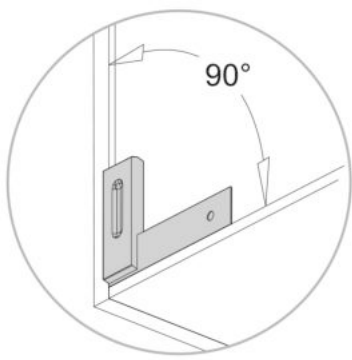
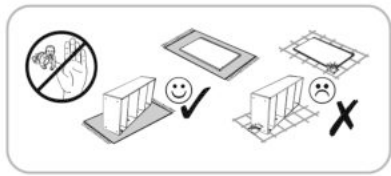

A=B

**M1**  
10x10x15 x10

**DA21**  
4,2x16 x4

**P14**  
45x20 x5

**D25**  
4x25 x5

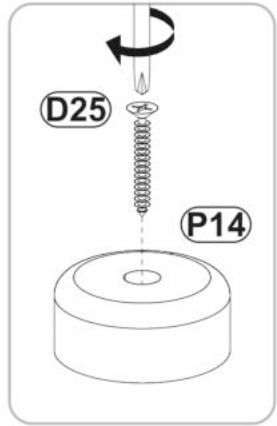
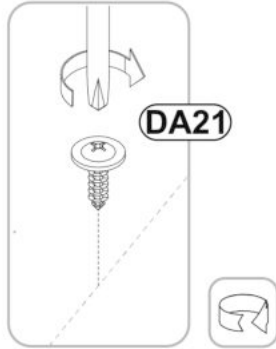
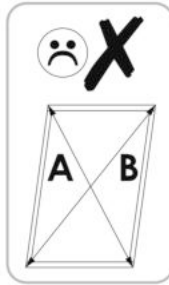
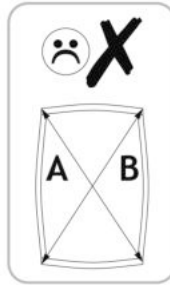
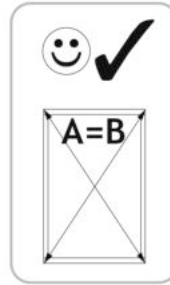
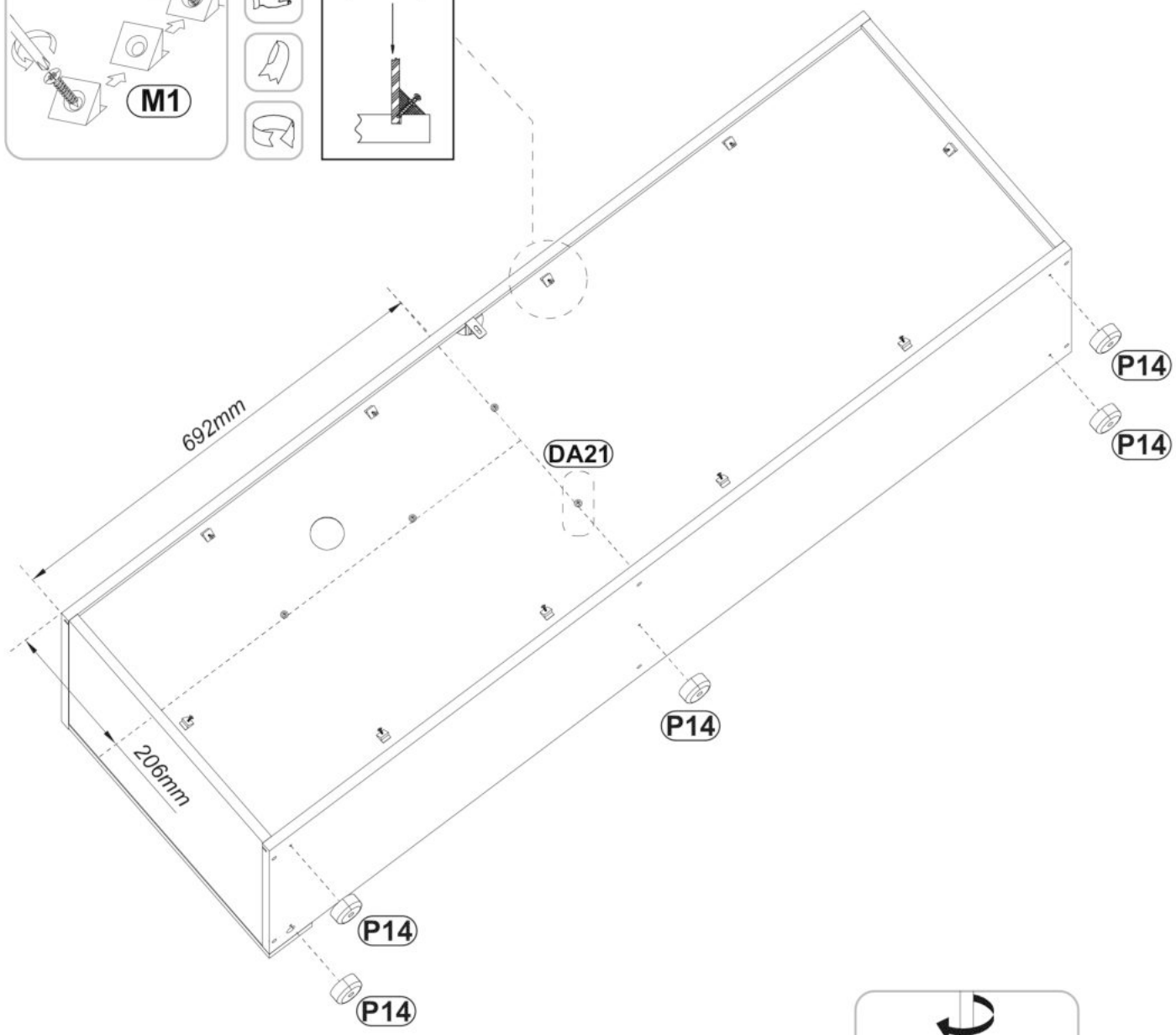
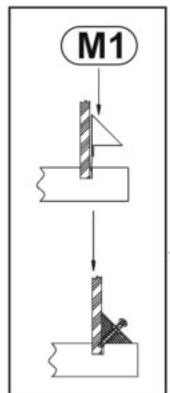
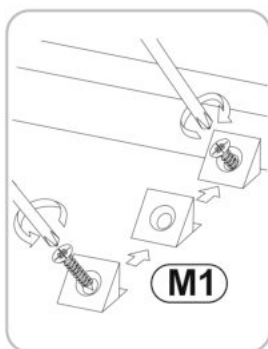

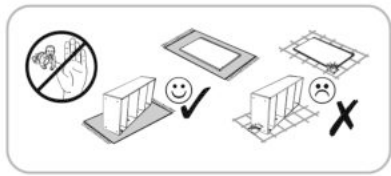



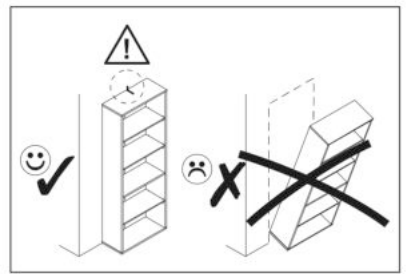
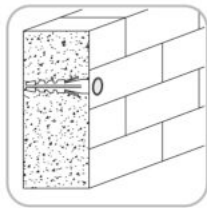
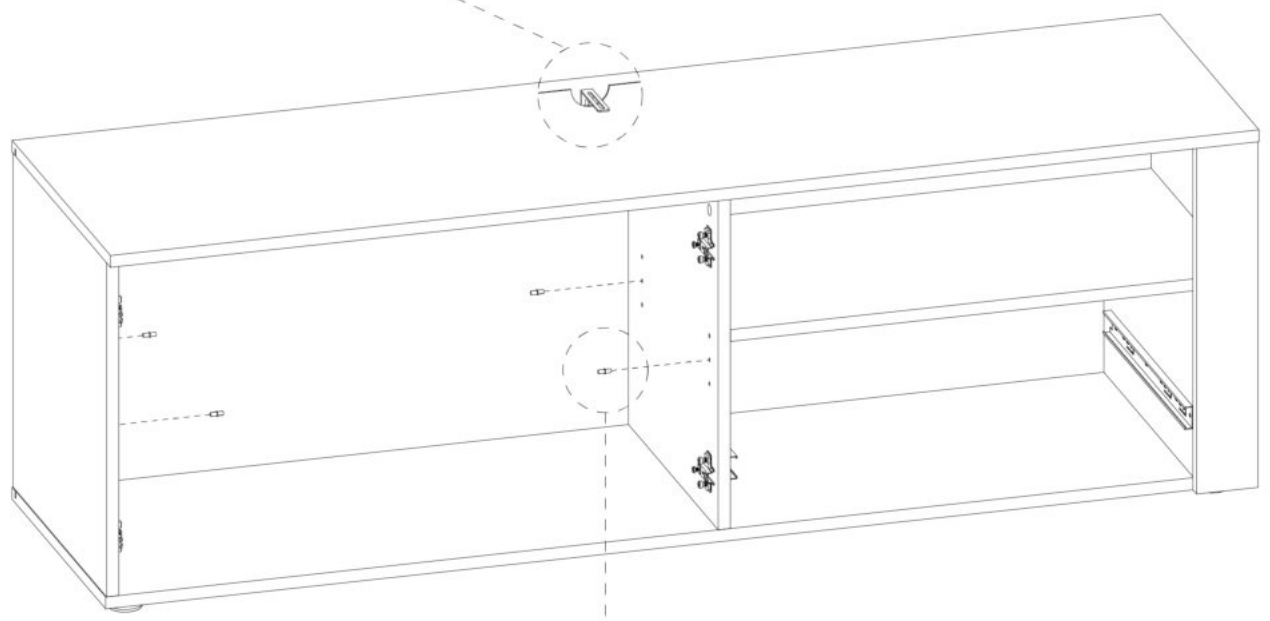
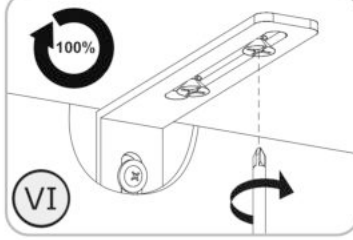
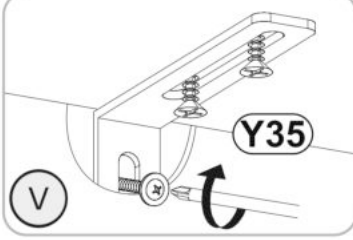
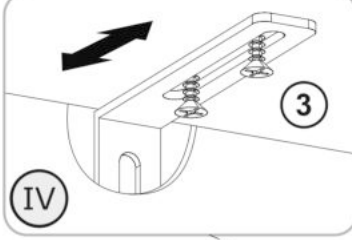
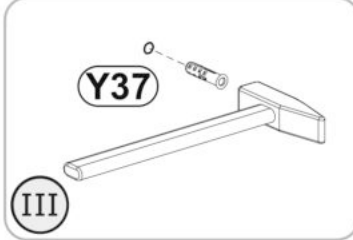
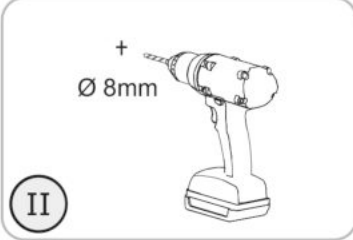
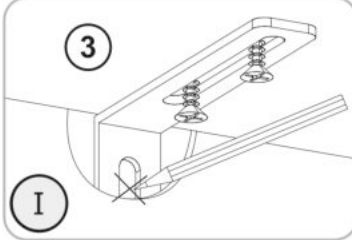

- (N1)** x4
- (Y37)** x1
- (Y35)** x1

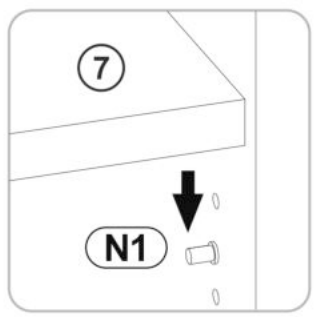
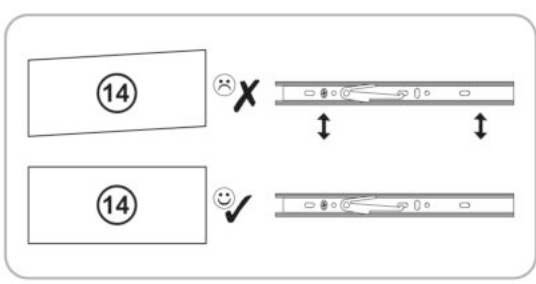
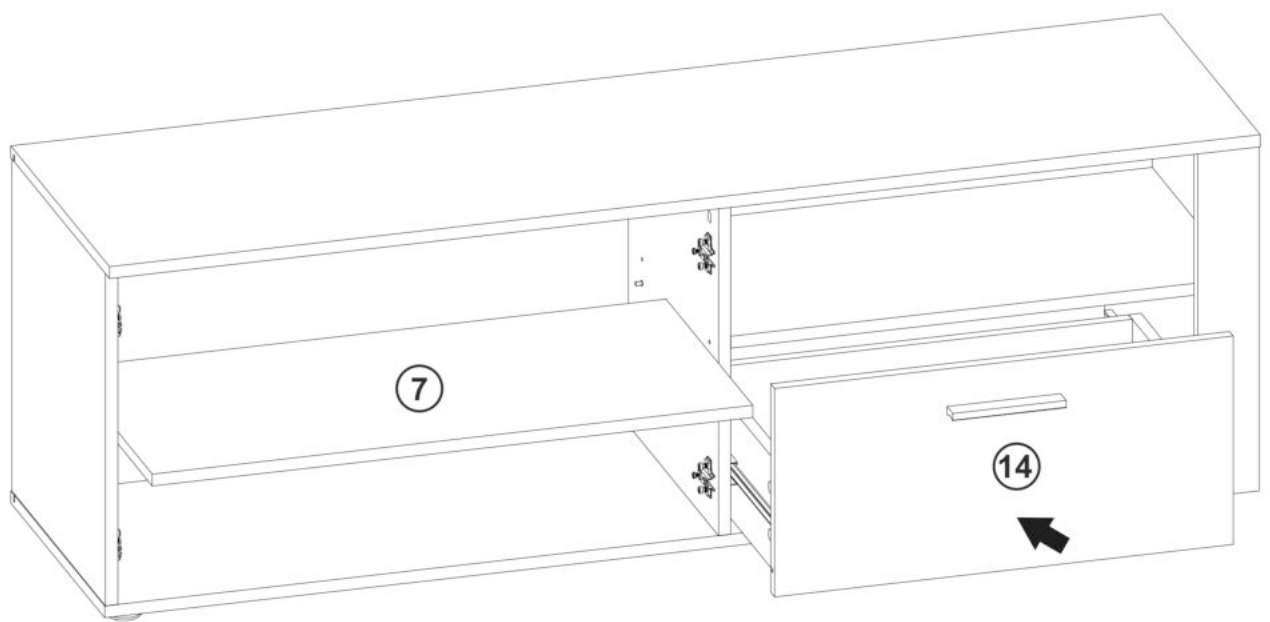
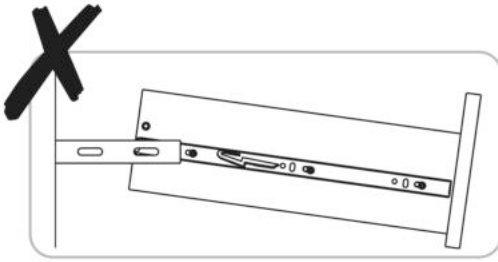
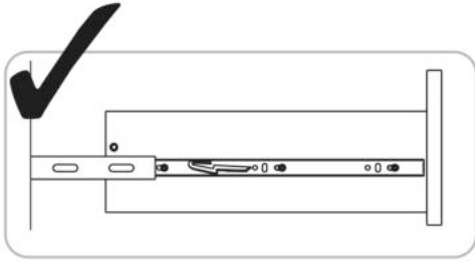
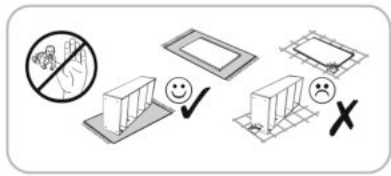

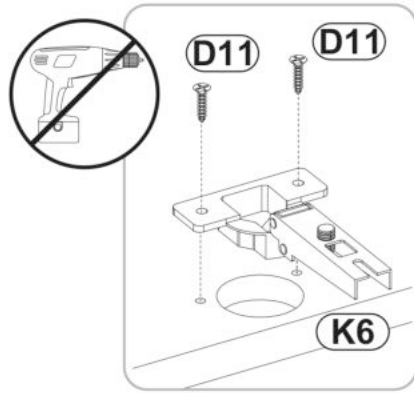
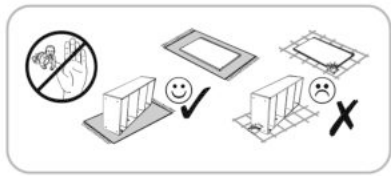
13

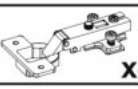



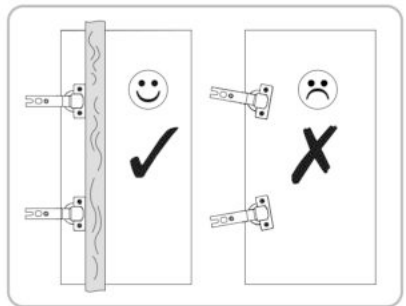
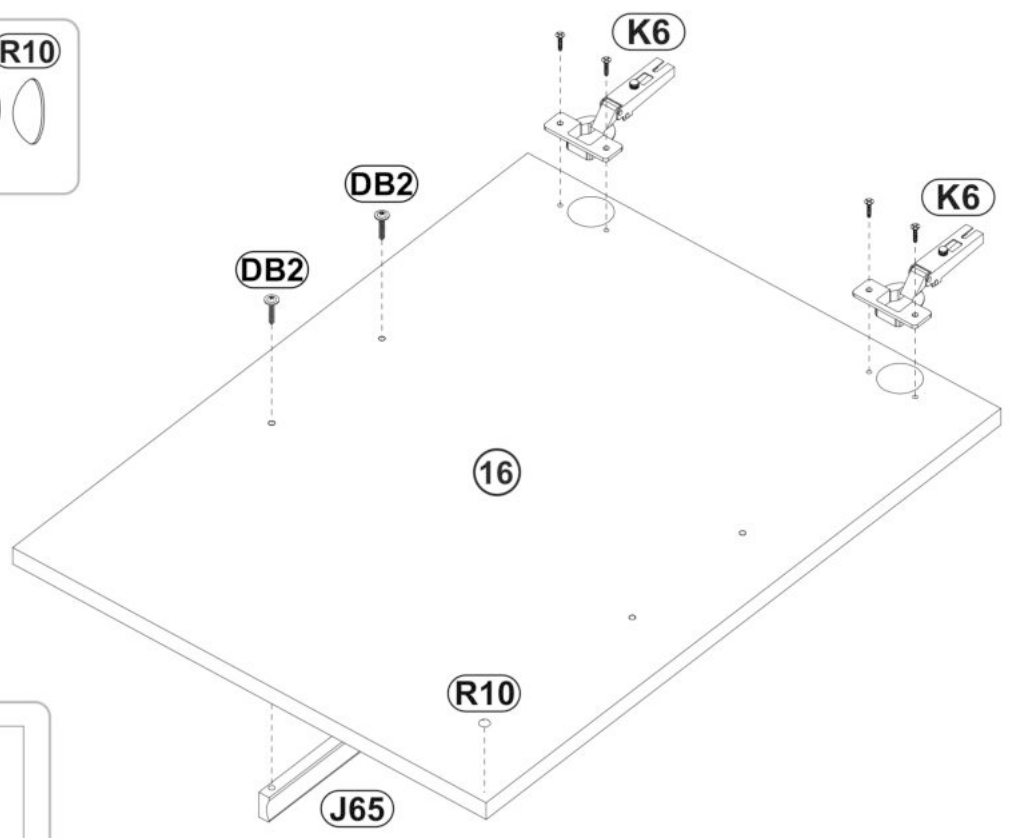
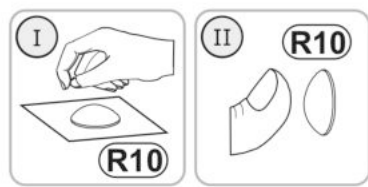
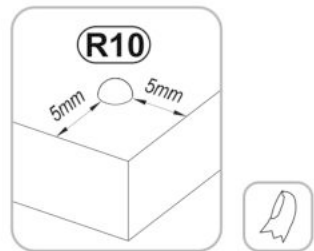
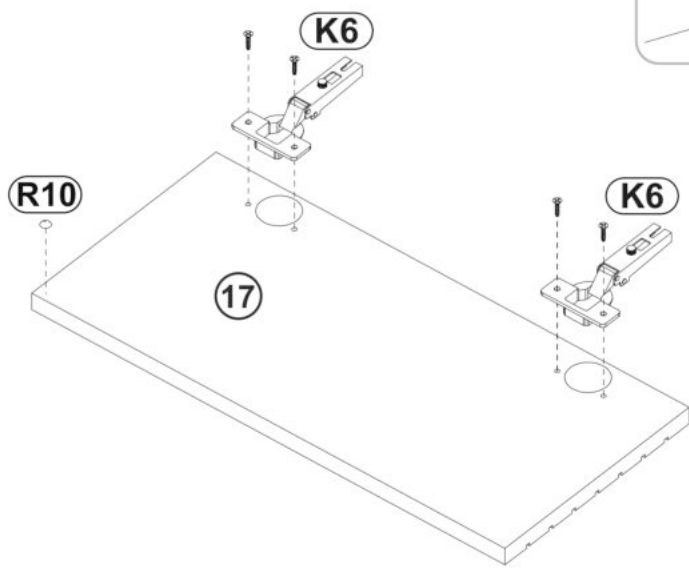

- K6**  x4  
Ø35
- D11**  x8  
3,5x16
- DB2**  x2  
4x25
- J65**  x1  
128/148
- R10**  x2  
Ø10



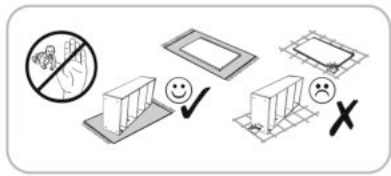

15



R6  x1

